

DESIGN OF INDEX JIG FOR THE DRILLING OPERATION OF VALLEE BAR

A Projectwork

By

FAROQUE AHMED

Submitted to the Department of Industrial and
Production Engineering for the partial fulfil-
lment of the requirements for the degree of
MASTER IN ENGINEER (IP).



February, 1985

DEPARTMENT OF INDUSTRIAL AND PRODUCTION ENGINEERING
BANGLADESH UNIVERSITY OF ENGINEERING AND TECHNOLOGY
DHAKA, BANGLADESH.

CERTIFICATE

This is to certify that the project work was done by me and that this work has not been submitted elsewhere for award of any degree or diploma.

Countersigned

Supervisor

Candidate

DESIGN OF INOXA JIG FOR THE DRILLING OPERATION OF FALLER BAR

A Project Thesis

By

FAROUQ AHMED



Approved as to the style and contents by

Handwritten signature of Dr. A.K.M. Nurul Amin.

1. Dr. A.K.M. Nurul Amin
Assistant Professor
Department of I.P.E.
BUET, Dhaka

Chairman
(Supervisor)

Handwritten signature of Dr. A.F.M. Anwarul Haque.

2. Dr. A.F.M. Anwarul Haque
Professor and Head
Department of I.P.E.
BUET, Dhaka

Member

Handwritten signature of Dr. M. Anwarul Azim.

3. Dr. M. Anwarul Azim
Professor
Department of I.P.E.
and
Dean, Faculty of Mech. Engg.
BUET, Dhaka

Member



#S3916#

CONTENTS

ACKNOWLEDGEMENT

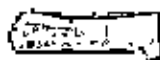

i

ABSTRACT

iii

CHAPTER - 1	Introduction And General Theory	1
	1.1 Introduction	1
	1.2 Design and its criteria	2
	1.2.1 Jig - Fixture predesign analysis.	4
	1.2.2 Jig - Fixture design consideration.	11
	Aims and objectives.	(4)
CHAPTER - 2	Analysis And Grouping Of The Job Alongwith The Description Of Existing Manufacturing Facilities.	15
	2.1 Analysis and grouping of the jobs.	15
	2.2 Description of the existing variant.	17
	2.3 Detection of problems and difficulties of the existing variants.	22
CHAPTER - 3	Probable Solution Of The Problems.	27
	3.1 Philosophy of modification.	27
	3.2 Description of the modified variants.	31

LIST OF THE TABLES

TABLE - 1	Faller bars of group 'A'	16
TABLE - 2	Faller bars of group 'B'	17
TABLE - 3	Faller bars of group 'C'	17
TABLE - 4	Gear position and indexed parameter	38
TABLE - 5	Economical analysis of the existing and the new variants	51
TABLE - 6	Technical comparison of the second and third variant	53
TABLE - 7	Overall comparison of the new variants	57

A C K N O W L E D G E M E N T

The author finds no language to express his deepest gratitude to Dr. A.K.M. Nurul Amin, Assistant Professor, department of Industrial & Production Engineering for his earnest help on the project, without whose talented guidance it might have been impossible to go on with the work.

The author is grateful to the management of Bangladesh Machine Tools Factory, Gazipur, Dhaka for providing facilities in carrying out the project work. This indicated their deep interest in promoting engineering education in the country. The author is also grateful to Mr. M. Nakib Ahmed, Assistant Engineer & Mr. M. Fariduddin Engineer, BMTF for their kind cooperation in this concern.

The author gratefully acknowledges his extreme thanks to Dr. Ing. M. Anwarul Azim, Dean Faculty

of mechanical Engineering, BUET. and Dr. A.F.M. Adwarul Haque Head of Industrial Engineering Department for their advice and encouragement.

The author recalls with esteem the cooperation of his close friends M. Mizanur Rahman, Assistant Engineer, BMTF and M. Nurul Islam for their generous cooperation and inspiration.

Adequate and explicit credit goes to those individuals and groups who have directly or indirectly helped the author in carrying out the project work. The author is deeply grateful to all of them.

INTRODUCTION AND GENERAL THEORY

1.1 INTRODUCTION

Jig is a work piece locating and holding device used with machine tools and provided with a tool guiding element.

Generally a jig serves the following purposes:-

- i) facilitates easy machining
- ii) ensures high quality
- iii) increases accuracy
- iv) ensures the use of less skilled operators
- v) increases tool-life
- vi) ensures reproducibility.

For these reasons comparatively cheaper and less precision machines may be used for relatively accurate works when a jig or fixture is added to them. At times without the use of proper jig and fixture the machining process becomes almost impossible. In mass and lot production the machining process is unthinkable without the use of proper toolings. Jigs & fixtures ensures high accuracy of the relative locations of the different holes which are to be accurately machined on different surfaces of a three dimensional work. Generally drilling of numerous identical holes, specially when they are small in dimension and closely located is a very monotonous job. It is also harmful to the eyesight of the

worker. In such cases if the process cannot be automated, at least a jig should be introduced to minimize the strain on the labourer and to raise the productivity of the machining operation by that particular machine or group of machines.

1.2 DESIGN AND ITS CRITERIA.

Mechanical engineering design is the use of scientific principles, technical informations and imaginations in the definition of a mechanical structure, machine or system to perform prespecified functions with the maximum economy and efficiency [1].

According to Matousek "a designer uses his intellectual ability to apply scientific knowledge to the drawings, which enables an engineering product to be made in a way that not only meets the stipulated conditions but also permits manufacture the same by the most economical methods [2]. According to the same author there are three kinds of designs, which are explained below:

a. Adaptive design:-

In this type of design only a minor change has to be made to adopt the existing product.

b. Development design:-

Such kind of design includes major changes. In this case a few or more extra facilities are added to fulfill & satisfy new demand.

But it does not aim at replacing the product by a new one.

c. New design:-

It is a new creation and there was no existence of such things or product at all previously in the same organisation or under the same management.

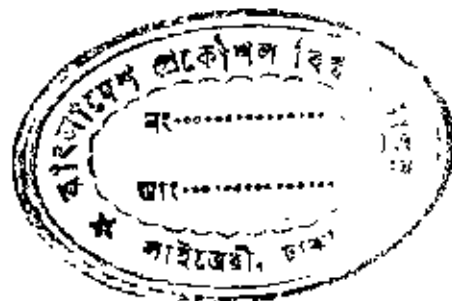

1.2.1 JIG FIXTURE PREDESIGN ANALYSIS

Before starting the design of a jig/fixture a lot of points are to be taken into consideration .

Among these following three are most important:-

1. Product consideration,
2. Operation classification & criteria consideration,
3. Machine and equipment classification & criteria consideration.

Above three are termed as Jig or fixture predesign analysis, namely 1st phase, 2nd phase & 3rd phase respectively [3].

1st phase-Product consideration

Before designing the product should be checked and analysed from the different points and different angles. In this phase the following consideration are made:-

a) The type of manufacturing processes the product has undergone during the previous machining operations i.e. Casting, Stamping, welding, Extrusion, Turning, Mill-shape etc.

b) Material used for the job, i.e.

- i) Ferrrous
- ii) Non-ferrrous
- iii) Non-metallic.

c) Mechanical & Metallurgical properties of the job material:

- i) Toughness
- ii) Elasticity
- iii) Hardness
- iv) Ductility
- v) Strength.
- vi) Machinability
- vii) Weight -
 - a) Amount of weight,
 - b) Load distribution, Moment of inertia, Center of gravity, etc.
- viii) Conductivity - (Electrical & Thermal)

Electrical conductive materials may be clamped by electrostatic method, whereas thermal conductivity for cutting condition.
- ix) Shock (Absorvity and bearing capacity)

etc.

d) Geometrical size and shape of the job to be machined: Shape mostly influences the type of jig we need, say Bar type jig, Vise jig, Universal jig etc.

e) Specification: The number of holes, bosses, slots, other surfaces or points and their positions on the job,

- i) Number, Size & Location
- ii) Linear relation (tolerances)
- iii) Angular relation (tolerances)
- iv) Finish (machined, ground)
- v) Other if any.

These informations are required for selection of the datum surfaces, characteristics and design aspects of a jig or fixture.

2nd phase: Operation classification & criteria consideration.

After the completion of the product analysis the job should be analysed from the point of view of operational classifications. This analysis is done in two steps (A) Operation's type consideration (B) Number and order consideration.

A) Operation's type consideration:

In this phase it is necessary to determine for which machining operation the jig or fixture is designed such as : Drilling, Boring, Reaming, Turning etc. This consideration determines the jig fixture type.

B) Number and order consideration: In this step it is necessary to determine the lot size, frequency of receiving orders etc., which will ultimately influence the design of jig & fixtures.

For a single product (simple type), for instance there is no need of jig or fixture but for the case of multiple products there may be a need for jig to facilitate higher rate of production.

3rd phase: Machine & equipment classification & criteria considerations

This analysis is done on the basis of Machine tools and equipment which are to be used for the operation i.e. this analysis is of machine tools classification or selection type. Machine tools are divided into two main groups:

A. Material removal type machines

B. Material nonremoval type machines.

A. In material removal type generally the following groups of machines are included:

- i) Milling type (vertical, horizontal etc.)
- ii) Drilling type (Precision, Sensitivity etc.)
- iii) Broaching type (Pull down, Single pull, etc.)
- iv) Boring type (Horizontal, Jig boring, etc.)
- v) Grinding type (Surface, Cylindrical, Centerless, etc.)
- vi) Turning type (Automatic, Vertical, etc.)
- vii) Threading type (Tapping, Die cutting etc.)
- viii) Polishing (Honing, Burnishing, etc.)
- ix) Ultrasonic metal removal
- x) Modern precision & ultra-precision metal removal type
(Laser beam etc.)
- xi) Metal removal by the hand tools (Chisling, Filing, Punching, Brushing, etc.)
- x) Friction type (Rubbing with soft metal to obtain super-polishing)

xiii) Reciprocating type (Planner, Shaper)

ixv) Gear cutting type

xv) Electrical metal removal type

xvi) Special

The type and size of machine tools greatly affect the selection of jig-fixtures feature, for instance the size of the bed and the tooling area will limit jig-fixture dimension.

B. Material non removal type includes :

1 Assembling

2 Inspection

3 Miscellaneous

1. Assembling :

i. Welding type (Resistance, Overhead, Underwater, etc.)

ii. Riveting type (Pedestal, etc.)

iii. Stapling, Sticking etc.

iv. Soldering, Brazing,

a) Electrical induction

b) Furnace

v. Other types

For assembly operation some time fixture may quicken the production rate, say riveting more than one at a single operation naturally

better than that of the single rivet at a time.

2. Inspection:

- i) Optical (comparator, etc)
- ii) Fixture indicating elements
 - a. Mechanical (Geared indicator, screwed, etc.)
 - b. Pneumatic, Hydraulic (Indicators, gages)
 - c. Electric, Electronic, Sonic (Pick-ups,
Meters, etc.)

For dimension checking optical instruments may facilitate automatic inspection say oversize products will go in way , undersize products will go another way and those with exact size will remain there.

3. Miscellaneous equipment:

- i) Painting (Spraying, Brushing)
- ii) Heat treating (Electrical induction, Salt bath)
- iii) Plating
- iv) Foundry operations.
- v) Peening, etc.

1.2.2 JIG FIXTURE DESIGN CONSIDERATIONS

There are lot of considerations to be made while designing a jig/fixture. These vary with types of jig/fixtures, e.g. the design steps and procedures of a milling fixture should not be similar with that of a drilling jig. Again a jig may serve more than one purpose. So point of consideration will also vary from one jig to another jig.

While designing a jig-fixture the following points are to be kept in mind 4 .

1. The main frame of the jig or fixture must be strong enough in order to prevent the deflection to the maximum extent due to force exerted during cutting and/or clamping.
2. It is a usual practice to build up the frames from simple sections which may then be either screwed or welded. Combination of both welding & screw is a good practice. Those parts are to be changed from time to time may be fastened with screws, and parts remain for the life of the jig or fixture may be welded. Complicated shapes may be cast from a good grade of cast iron
3. Location of the Job in the jig is an important point so there

must be arrangement of locating work at the exact place.

4. Fixture should be so designed that the work loading & unloading will be easy.

5. Rapid and easy clamping should be the characteristic of a good jig/fixture.

Clamping devices arrangement should be such that clamping and unclamping operations may easily done. This should be done without removing the clamp.

Whenever possible, clamps should be supported with springs so that the clamps are held against the bolt head.

6. Lumper pin, block or any other obstruction should be made to swing the work only as far as necessary.

7. All clamps supports & locators should be clearly visible to the operator and easily accessible for cleaning, positioning or tightening.

8. If possible all clamps & supports which need to be adjusted with a wrench or spanner would be the same size and should be capable of being operated from the front of the fixture.

9. There must be definite place or places to keep the loose parts (adjusting tools, bushings etc.) to prevent slip away. These may be fastened with flexible cord or chain.

10. Location must be unique and clamping should be rigid

11. Support points and other parts should be in such a way that it can easily be replaced if those break or wear.

12. For the case of jigs, provisions must be made for easy chip removal

13. Tolerance of the work must be in a reasonable limit but not close.

For the closer tolerance, the cost of manufacturing of the work is higher. But should not be far away so that interchangeability affects.

14. Safety of operators must be taken into considerations.

AIMS AND OBJECTIVES

The existing procedure for the drilling of holes is inaccurate, slow and it is moreover monotonous for the operator and very much harmful to the eye sight of the machine operators.

Therefore the aim of the present work is to :-

1. increase productivity,
2. lower down the cost of production,
3. raise accuracy of production(machining), minimise operators labour and his eye sight fatigue.

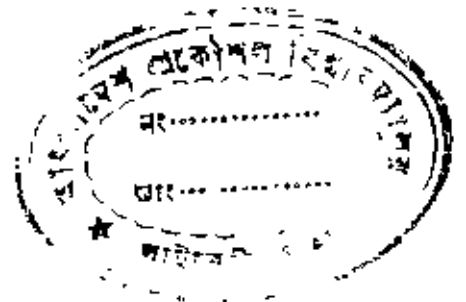

ANALYSIS & GROUPING OF THE JOBS ALONGWITH THE
DESCRIPTION OF EXISTING MANUFACTURING FACILITIES

2.1 ANALYSIS AND GROUPING OF THE JOB :

Bangladesh Machine Tools Factory manufactures seven types of faller bars:-

1. Faller Bar Round head (second drawing): for Chittagong Jute Manufacturing company Limited (Fig. - 1)
2. Faller Bar Square head (second drawing): for Platinum Jubilee Jute Mills Limited (Fig. - 2) .
3. Faller Bar Square head (second drawing) : for Crescent Jute Mills Limited (Fig. - 3) .
4. Faller Bar Round head (finisher drawing) : for Aleem Jute Mills (Fig. - 4) .
5. Faller Bar Square head (finisher drawing) : for Aleem Jute Mills (Fig. - 5) .
6. Faller Bar Square head (first drawing) : for Crescent Jute Mills Limited (Fig. - 6) .

The seventh type of Faller bar is of crank type, which is completely dissimilar with the previous six. This is made of round bar whereas rest six are flat that is why seventh type of faller bar is not included in this study.

Groupings of the Faller bars are made on the basis of center distance between the two successive holes in a grill, since the requirement of jig design is for drilling hole for insertion of pins at uniform distance.

Specifications of the faller bars of three groups are given in table - 1, 2, & 3 respectively.

TABLE - 1.

Sl No	Size of the faller bar	No. of Grill	No. of Rows	No. of Pin/grill	"a" inch	"φ" inch	"d" inch
1	$32\frac{1}{4} \times \frac{11}{16} \times \frac{13}{32}$	6	2	13+14	1/4	0.07	1/4
2	$32\frac{1}{2} \times \frac{11}{16} \times \frac{13}{32}$	6	2	13+14	1/4	0.07	1/4
3	$32\frac{3}{4} \times \frac{11}{16} \times \frac{13}{32}$	6	2	13+14	1/4	0.07	1/4

"a" is the centre distance between two successive holes.

"φ" is the diameter of the holes

"d" is the intermediate distance between two grills.

TABLE - 2.

Sl No	Size of the faller bar	No of Grill	No of Rows	No of Pin/grill	"a" inch	"φ" inch	"d" inch
4	$26\frac{3}{4} \times \frac{11}{16} \times \frac{13}{32}$	4	2	21+20	1/5	0.07	1½
5	$26\frac{3}{4} \times \frac{11}{16} \times \frac{13}{32}$	4	2	21+20	1/5	0.07	1½

TABLE - 3.

Sl No	Size of the faller bar	No of Grill	No of Rows	No of pin/grill	"a" inch	"φ" inch	"d" inch
6	$35 \times \frac{3}{4} \times \frac{13}{32}$	4	2	12+13	½	0.07	1½

The grouping has been done to get maximum facilities from minimum number of Jig. In the absence of these groupings, the number of jigs needed for the six faller bars would have been six, but in actual case it is much lower.

2.2 DESCRIPTION OF THE EXISTING VARIANT.

There is an arrangement to facilitate the drilling operation in the existing Jig. The existing jig is a plate type one, with

the arrangement of longitudinal and cross movement (Fig. - 7)

The existing variant consists of the following parts:

Drawing Index	Part name	Quantity
1	Base	1 Nos.
2	Guide plate	2 "
3	Hexagonal screw	20 "
4	Hexagonal nut	6 "
5	Round head screw	6 "
6	Hexagonal nut	2 "
7	Cross slide screw	1 "
8	Bush	1 "
9	Counter shank screw	2 "
10	Guide plate	1 "
11	Tray	1 "
12	Clamping screw	3 "
13	Jig body	1 "
14	Pin	4 "
15	Socket head screw	4 "
16	Hexagonal bolt	3 "
17	Plate	1 "
18	Sliding rail	2 "
19	Nut	2 "
20	Grup screw	3 "

Drawing Index	Part Name	Quantity
21	Grup screw	3 Nos
22	Jaw	2 "
23	Jib	1 "
24	Fixing plate	1 "
25	Hexagonal screw	2 "
26	Counter shank screw	4 "
27	Bush	1 "
28	Wheel	2 "
29	Handle	2 "
30	Longitudinal screw	1 "
31	Key	2 "
32	Hexagonal bolt	2 "
33	Lead	1 "
34	Socket head screw	4 "
35	Pin	4 "
36	Coolant drain nozzle	1 "
37	Clamping bolt angle	3 "

Two channels are welded together (leaving gap in the middle)
to form the base of the jig. Guide plate (No- 2) is a rectangular
bar screwed with the Plate (No- 20) by hexagonal screw (No- 3)
The upper side of the base is used as slide way and the lower side
is fastened to the bench by screw (not shown in the figure)

For marking operation the jig plate (Not shown in the figure) is fastened to the jig body (No - 13) with the hexagonal bolt (No - 16) , when drilling operation is done the jig plate is taken out.

OPERATIONAL PROCEDURE

To describe the operational procedure the index of figure - 7, and the same figure is used. The Job is clamped in the fixture by three clamping screw (12) with the support of jig body (13). The two ends of the job rest on the two clamping bolt angle (37). There is a fixing plate (24) fastened with the Jig body (13) by two hexagonal screw (25) for positioning the job. Plate (24) also limits the displacement of the job while resetted it after any interruption of drilling in case of any accident.

Marking jig plate is fastened by countershank screws (4) to the jig body over the jobs . Three jobs are clamped together so that loading and unloading are not frequent.

Marking operation is carried out by using a center drill. After marking the actual drilling is done for the whole depth.

Generally for drilling the jobs are transferred to another drill machine rather than disassembling the jig plate, one/two machines are used for marking operation & when it is over, these machines are remain idle, which ultimately leads to higher cost of production.

In case of long breaks of drill bits the broken part may be removed from the job with difficulty. In the case of short breaks it cannot be held at the top for taking out & then the jig has to be disassembled from the jig-body for removing the broken drill bit.

The horizontal movement is done by Longitudinal screw (30) and Cross slide screw (7), the screws are rotated by means of two hand wheel (28), which are furnished with handles (29).

The revolving motion comes from the wheel rotation, & it is converted into the longitudinal motion of the table by means of a 6 TPI ACME thread screw (30) and nut (19). This revolving motion is supplied to the wheel manually.

After the drilling operation the job is unclamped and the final operation i.e. the pin insertion is done.

2.3 DETECTION OF PROBLEMS AND DIFFICULTIES OF THE EXISTING

VARIANTS.

From discussion with the factory management, technical personnels and machine operators it was clear that following problems and difficulties encountered in drilling holes using the existing facilities:

1. No of pins: It is found that in a single Faller bar there are 100 Nos to 164 Nos of pins. In the first drawing 100 Nos of pins in the second drawing 162 Nos of pins and for the Finisher drawing there are 164 Nos of pins in a Faller Bar. So each and every faller bar requires the corresponding numbers of holes to be drilled. This variation in hole number causes problem in setting unique technique for the operation.
2. Hole size and depth: The hole to be drilled is very narrow & in the order of 0.07 inch. Moreover, it has to be drilled to a depth of $\frac{3}{4}$ inch. Overhanging length of the drill-bit is approximately 2 inches.
3. Drill bit and size: Since hole size is 0.07 inch naturally shank dia and body dia. of the drillbit is less than this.

That is why the ratio between the length and the diameter is too high (29:1) and exceeds its critical value. Due to its slenderness drill breaks frequently. Moreover it is an inaccessible region for the coolant, as a result of this heat removal from this cutting zone is very slow. Because the temperature rise. As such tool (drill-bit) blunts rapidly and cutting force increases due to the bluntness (increased friction) of the tool.

4. With-drawal of broken bits from the job & the jig : Since the hole is narrow and deep, if drill breaks it cannot be removed quickly and easily. Sometimes the job and the Jig are to be removed from the fixture, which is difficult due to the additional operations of clamping, unclamping. The resetting of the job is a difficult locating problem.

5. Chip removal : Since the hole is narrow, deep and the flute space inside the drill, meant for the chip removal is extremely small, it is very much difficult for chip to come out freely. Also chip can easily get stuck in the midway ultimately causing breakage of the tool (drill-bit).

6. Indexing : For indexing existing arrangement is screw-thread. There is no measuring or controlling device to locate exact position of the hole to be drilled on the faller bar for the next operation.

7. The marking operation : In the existing variant "Marking" is done by a centre drill using jig plate in one operation, and the actual drilling in a different operation, which ultimately increases production time by a considerable amount, if not doubled.

8. Operator's eye fatigue : Operator has to drill at the proper point previously marked otherwise inaccuracy comes and radial force acting on the drill tip tends to bend the drill from its axis resulting in force vibration and ultimate breakage of the drill . Moreover the marked points are so small in dimension that it is extremely difficult for the operator to continue for hours together to carry out drilling operation, looking these points accurately.

9. Double clamping : Each and every work is clamped twice, once for marking at the surface by using a marking jig and second time for drilling holes. So the indexing problem comes for the second time.

10. Costs : The total expenditure rises up due to the absence of proper matching methods in the existing variant. Cost rises

due to increased machine hour, labour hour, power consumption etc.

11. **Mis scheduling** : No body can say exactly when the drill will break to cause accident. It has been found that in drilling a single faller bar five drill bit had been broken . Although this is an uncommon event it affects the production time, as a result of which delivery is delayed and naturally goodwill is affected.

12. **Rigidity** : Drill breaks frequently. ~~The cause of this may be~~ low rigidity of the jig. Longitudinal or cross movement of fixture during drilling operation due to the fact that the table is not positioned positively during the drilling operation causes the drill bit to break frequently.

From the above considerations the following conclusion can be drawn.

Since drill breakage is a major problem .If possible it should be stopped if not frequency of drill-bit breaking should be minimized to a reasonable extent.

The production delay is a major economical problem .
needs a solution.

The technical problem is indexing so an indexing facility should

be added to facilitate easy indexing.

The operators face eye fatigue and that is why they get tired rapidly and the production hampered. This should be taken into consideration in the new variant.

Cost of production should be lowered and scheduling should be improved so as to raise profit rates and productivity of the operation.

The rigidity of the jig may cause inaccuracy, tool breakage that is why rigidity of the jig should be raised.

PROBABLE SOLUTION OF THE PROBLEMS

3.1 PHILOSOPHY OF MODIFICATION

Modern manufacturers are conscious about the cost of production. Sometimes the technical appraisal for the manufacturing may stand with less priority. For the production of special parts, cost constraints are of secondary importance whereas its need in manufacturing is the first coming element.

For an adaptive design change is minor which cannot give the solution for our problem and for new design as it is the complete new creation we have to move towards a development design, where an appreciable modification is encountered, stepwise, with changing the parts we want to have the optimum utility which is the designers motto.

To have the maximum utility from the minor change of the existing facilities, the parts may be replaced for new one but the fixture will remain there.

In the drilling operation the drilling is not only the problem but drilling in position is also a problem. Here a number of holes are to be drilled with almost a needle like drill.

The problems lie therein are:-

Tool breaks frequently in this particular case due to excessive cutting force, excessive heat, low rigidity and differential cutting force mainly.

Tool breakage can be minimized if the influence of the above mentioned factors are individually reduced to the reasonable extent.

To minimize excessive cutting force cutting fluid of a good grade is to be used. Moreover the drill bits are to be sharpened after a certain number of operations, which should be found out experimentally.

To minimize excessive heat, coolant of a good grade may be used. This heat is caused by the friction during cutting. If heat can be carried away from this cutting zone to any other place, the rise of temperature may be minimized. But the best practice is to lower the heat generation due to friction.

Rigidity of the drill bit is low since the length to diameter ratio is higher than its critical value. Due to the job limitation, the diameter or length of drill cannot be changed & therefore drill breaking cannot be prevented by changing the ratio. If it is possible to raise the toughness of the drill material, then the tool breakage may be lowered.

The differential cutting force is developed due to a number of causes :-

- i) Positioning at offcentre while drilling the hole after the completion of marking operation .
- ii) Free movement of the table while drilling the hole.
- iii) Heterogeneous grain structure in the job material.
- iv) Differential hardening by heat treatment.

Heterogeneous grains in the job material is a casting difficulty which is beyond the scope of the present work and that is why differential heat-treatment is not included in this discussion. Although this phenomenon is not very common in the job material and its influence on the tool breakage is also negligible, hence the point differential heat-treatment i.e. heterogeneity in the grains may be neglected.

It is possible to minimize the offcenter positioning of the drill bit during drilling after the marking operation has been carried out, if the operation of the drilling and marking is possible at a time. The free movement of the table along with the fixture may causes fatigue failure of the drill bit. Naturally this should be avoided by preventing the movement of the table during drilling.

and tool breakage.

The indexing and it substantially influences the cost of production

The solution to the problem of workers eye fatigue & double clamping

If drill bit breakage it can be replaced by removing only the drill bush.

but rigid during operation, it can give the solution of the problem.

will also reduce. If a jig bush is used which is easily replaceable

If drill breakage is reduced, removal of "broken drill bit" problem

would be necessary to select the exact position of the hole to be drilled.

An indexing facility may be added with this, so that no eye estimation

the double indexing will be cut-off.

hole drilling, the marking can be avoided consequently difficulties of

if a jig is used which would continuously guide the drill bit during

-Now the problem is to drill in a single operation without marking.

positioning of the table.

This is possible by increasing the rigidity of the fixture and exact

3.2 DESCRIPTION OF THE MODIFIED VARIANTS

To avoid marking a jig bush is proposed for all the new variants to guide the tool. The jig bush should satisfy the following requirements:

- i) continuous guidance of the tool,
- ii) replacibility,
- iii) reusability,
- iv) low cost,
- v) no accumulation of chip & provision for coolant flow,
- vi) high rigidity.

The jig bush is placed on a stand which is fixed on machine base i.e. with the bench. The stand is welded with the bench so that rigidity increases. From fig it is clear that there is a place on the jig body to set the jig bush (fig-7). A key is there to increase the rigidity of the jig bush with the jig bush holder. Jig body is rigid when it is fastened with the stand by means of the key. When the bush requires replacement or machining it may easily be taken out by withdrawing the key.

For indexing, existing variants has a screw of 6 TPI ACME thread, it only converts revolving motion to the linear motion. To measure the distance some auxiliary parts are to be added.

THE FIRST VARIANT

A screw having pitch "a" is introduced in this variant at the place of previous one, where "a" is the center distance between the two adjacent holes in a grill. Therefore each and every rotation of the screw would give a linear displacement equivalent to "a".

To measure one revolution exactly a point is set on the wheel (fig-7) so that it can give an indication of one revolution (starting & ending).

Operational feature

Each revolution of the wheel gives a linear distance "a" of the table. The rotation is controlled to a single revolution by a pin which is spring actuated. There is an indexing point on the wheel (28, fig-7) at the left side. This pin locks automatically when one revolution of the wheel is completed. It requires only a few force to overcome the lock & to rotate the wheel for next rotation. The end point of the previous indexing is the starting point of the next indexing.

This facilitates easy indexing.

Since clamping accessories are not changed in the new variant the clamping and unclamping is same as in the existing one.

THE SECOND VARIANT

In the "First variant" each and every revolution gives a linear movement equivalent to the thread's pitch

center distance between two adjacent holes in a grill

the distance between the successive grill may be an integer multiple of "a" or a fraction multiple of "a". If it is fraction multiple of "a" then it is difficult to use the jig described in variant-1, since it only controls the movement of the wheel by one revolution. For an integer multiple of "a" the wheel should be rotated more than once, and the number of rotation required is upto 9 (nine) for the given faller bars.

To eliminate this, second variant is designed. Here four pairs of gears are added to give the linear movement equal to the distance between the grills by one and only one revolution. For making this versatile instead of a screw three screws are used. This three screw will give three sets of indexing

The mechanism designed in first variant has been used in the second variant for measuring the exact revolution of the wheel. In this variant a little larger wheel is added to get more mechanical advantage (fig-10)

From the three pairs of gears, one pair is used for indexing the revolving motion and the rest two pairs of gears are used to index the intermediate distance between the two successive grills.

(one pair of gears are used for one group of faller bar)

According to the assembly one revolution of the wheel ~~is~~ of the screw displace the table longitudinally by "a" distance since the pitch of the screw is "a", so for "d" distance the wheel should rotated by an amount " d/a ".

Where "a" is the center distance between two successive pins in a grill and also the pitch of the screw, "d" is the intermediate distance between the two successive grills.

Operational feature

In this variant there is provision for new screw. A pair of gear is used to obtain the linear movement equivalent to the intermediate distance between two successive grills as mentioned earlier.

While center distance between two pins in a grill is to be indexed the procedure is similar to the first variant, But the motion should go through some gearing. While indexing the intermediate distance between the two grills "d" the motion will be transferred to the screw through a gear train (Fig-10) so that only one revolution of the wheel will be sufficient to provide the displacement of table equals to "d".

The gears are changed to index the intermediate distance by means of a lever, and after completion of the one revolution the lever is again turned to its original position to make ready the assembly for indexing center distance. Actually this lever change does not require any time because this changing can be completed

during drilling a hole.

There is an extra pin in one of the two rows of a grill, and it is identical for all the faller bars, so the intermediate distance is lower by an amount "a". That is why the intermediate distance of the -is row requires one extra revolution of the wheel, keeping lever at the normal position after the one revolution of the wheel. Therefore the table moves an additional amount of "a" with the previous intermediate distance.

To engage the gears the lever "C" should turn to the right by the handle "D₂", so that gear "G₁" should mesh with "G₆". Due to the gearing effect the linear movement increase to the distance equal to the distance between two successive grills.

THE THIRD VARIANT

In the second variant one screw thread set would give only a single type of indexing i.e. for indexing different hole distances, screws with different pitches are required. It is a cumbersome job to change the screws frequently for drilling different types of failer bars.

To avoid this arrangement should be made to get a number of indexing using only one screw. That is why a gear box is added to obtain the different sets of indexin parameters by changing the gears only. Six gears are set on three shafts, two gears for indexing the center distance between the two successive pins in a grill, other two gears for indexing the intermediate distance between the grills and two gears are used for reversing the direction of revolving motion. A collar is used to keep the gears in position, a lever arrangement is added there for changing the gears position.

Gears of "8" P_d are used for the gear box and a screw of 1 thread per inch has been used.

The indexing ratios are 1:2, 1:4, 1:5, 3:2, 5:4, to get corresponding distances of $\frac{1}{4}$ inch, $\frac{1}{2}$ inch, $\frac{1}{5}$ inch, $1\frac{1}{2}$ inches, $1\frac{1}{4}$ inches.

90 numbers of teeth are required to satisfy the above ratios (from the L.C.M. of the above ratios)

For $\frac{1}{4}$ inch distance the gear set is to be used	30,60
" $\frac{1}{2}$ " " " " " " " "	18,72
" $\frac{1}{5}$ " " " " " " " "	15,75,

For 3/2 inch distance the gear set is to be used	54,36
" 5/4 " " " " " " " " " "	50,40

Operational-feature

The clamping and unclamping procedure for the job are same as in the variants described above. In this variant (Fig-11) the gear at the position "G₅" needs no change, it is used for reversing the revolving motion. By changing "G₁", "G₂", "G₃" and "G₄" only different center and intermediate distances can be indexed.

When "G₁" and "G₂" gears are in mesh the center distance between the two pins in a grill can be indexed by only one revolution of the wheel "C". The meshing of gears may be changed by the lever "1".

For different center and intermediate distances the gear setting positions will be as mentioned in the table-4 given in the next page.

For the holes of second row of the faller bar the intermediate distance is higher by one center distance as mentioned earlier. So it needs an additional movement of one center distance than that of the first row. It is to be done in the same way as the second variant.

TABLE - 4

	POSITION OF THE GEARS				INDEXED PARAMETER
	G ₁	G ₂	G ₃	G ₄	
N O F T E E T H	18	72	X	X	a ₁
	X	X	50	40	d ₁
	15	75	X	X	a ₂
	X	X	54	36	d ₂
	30	60	X	X	a ₃
	X	X	54	36	d ₃

a₁, a₂ & a₃ are the center distance of the faller bars of Group-A, Group-B, Group-C respectively.

d₁, d₂ & d₃ are the intermediate distance between the two grills for the Group-A, Group-B & Group-C respectively.

The gear set at the position G₃ may be used for the future modification.

THE FOURTH VARIANT

Assembly drawing of the fourth variant along with parts list is given in Fig-12. Detail drawings of the parts are given in the Fig-12A, B & C

The procedure of clamping and unclamping is similar to the variants described earlier. Before indexing, the pin "N" is to be set into corresponding hole of the pin-holder "P". While drilling 1st row of holes the pin N_1' comes in contact with the 1st side of the wheel "L". After completion of drilling one row of holes pin N_2' is released to come in contact with the other side of the wheel & at the same time pin N_1' is taken out of contact.

The wheel "L" is to be rotated manually by means of handle "D₂". Figure-12. The conical grooves on the both sides of the wheel are the indexing points. The pin "N" locks the wheel "L" by the spring force of the spring "O". After completion of drilling a hole the wheel "L" requires a little force to overcome the spring force on the pin "N" for unlocking.

The wheel "L" is to be rotated for drilling the next hole. The revolving motion is transferred to the gear train by means of a shaft "E₃". The gears transfer the revolving motion to a pinion "G₆" which transfers the motion to a rack "A". The rack converts the revolving motion into linear motion for the table.

The wheel automatically controls the distance to be covered. As in the second and third variants it does not need an extra work for indexing

the intermediate gap between the two grills of pins.

Anticlockwise rotation of the wheel correspond to motion of table right, and this movement is necessary for drilling the holes of first row. Clockwise rotation of the wheel causes the movement of table towards the left and this movement of the table is required for drilling the holes of second row and at this condition there is no need of extra rotation of the wheel. The pin "N" will select the index point for the distance required.

Operational features of the 4th variant

Indexing mechanism used in this variant is different from the previous three variants. It is mainly equip rack and a pinion. One new pair of gears is required for this mechanism. Drill bush used in this assembly is same as in the earlier variants.

The wheel is the speciality of this variants. There are many indexing points on the wheel. These points give the indication of center distance between the two pins in a grill or intermediate distance between two grill as per requirement. The wheel is made of W/s plate, the index holes are machined with a center drill to imparts required conical shape.

The gap between two holes on the wheel are calculated as follows:-

For indexing the distance between two successive holes "a", the table & the rack are to be displaced by the same distance. Since the pinion G_6 Fig-12 is in the mesh with the rack, it has to be rotated by an amount $a/4D_6$, where D_6 is the pitch diameter of the pinion. This rotational motion has to be transmitted from hand wheel, through shaft-H, gears G_8, G_6 & G_7 . Transmission ratio between gear G_8 & pinion G_6 may be calculated as follows:-

$$i = \frac{D_6}{D_7} \times \frac{D_7}{D_8}, \text{ where, } D_7 - \text{ is the pitch diameter of the gear } G_7$$

$$D_6 - \text{ is the pitch diameter of the gear } G_6$$

$$D_8 - \text{ is the pitch diameter of the gear } G_8.$$

So, corresponding to "a" rotation the pinion G_6 gear G_8 will have

$$n_8 = \frac{a}{4D} \times i = \frac{a}{4D_6} \times \frac{D_7}{D_7} \times \frac{D_7}{D_8} = \frac{aD_7}{4D_6D_8} \text{ revolutions}$$

From fig-12A it can be seen that,

$$D_6 = 2$$

$$D_7 = 4$$

$$D_8 = 5$$

$$\text{So, } n_8 = \frac{a \times 2}{4 \times 4 \times 5} = \frac{a}{10} \text{, revolutions.}$$

Since gear G_8 and hand wheel L seat rigidly on shaft H, so the rotation of the hand wheel also be equal to " $a/10$ ".

Assuming that the indexing holes are machined on a circle of diameter D, on the hand wheel L, the circular distance between two adjacent holes will be :-

$$4D \times \frac{a}{10} = \frac{Da}{10} \text{ inches.}$$

COMPARATIVE STUDY OF THE EXISTING & MODIFIED VARIANTS

4.1 ECONOMICAL ANALYSIS

The project covered only the design of a jig but not the manufacturing of the same, that is why it is not possible to analyse it quantitatively rather than qualitatively. Only a rough estimation is done to evaluate the proposed jig from the point of cost, manufacturing and operational point of view.

Modification starts from the jig bushing introduction. This jig bushing reduces problems but only a few problems got solutions. The modification continues further at different stages which gives different return and these are brought in discussion as follows

The First variant:-

If only an identical group of faller bar is to be produced on a particular drill machine then it is very good, probably the unique solution is this, but the intermediate distance should be multiple of the center distance between two holes "a".

In this variants it only requires the following details:

- (a) Jig bushing assembly
- (b) Pin
- (c) Pin holder
- (d) Spring

So the cost of modification is very low and probably negligible.

For a particular type of faller bar

- i) reduces drill breaking cost
- ii) reduces idle time due to the absence of
 - a) double clamping
 - b) double indexing
 - c) marking
- iii) reduces drill breaking cost, so removal of broken drill bits cost also reduced.

consequently all the problems were identified before, are almost solved

TIME RATES FOR THE EXISTING VARIANT

Marking :-

I) Clamping & unclamping time	:-	0.283	sec/hole
II) Indexing time for center distance	:-	4.00	"
III) Indexing time for intermediate distance	:-	1.01	"
IV) Time required for machining	:-	2.00	"
*** Time required for machine change	:-	0.542	"

Actual drilling:-

I) Clamping & unclamping	:-	0.283	"
II) Indexing time for center distance	:-	4.00	"
III) Indexing time for intermediate distance	:-	1.01	"
IV) Time required for machining	:-	8.00	"
Total		21.128	"

Cost involved in the operation

Operator's cost	=	= Tk 10/hr
Machine cost	=	Tk 18/hr
Administrative expenses & other overheads	=	Tk 56/hr
Total		<u>Tk 84/hr</u>

i.e. Tk 0.02333/sec

Approximate time rate for the modified variant of first type:-

I) Clamping & unclamping time	:-	0.283 sec/hole
II) Indexing time for center distance	:-	3.50 sec/hole
III) Indexing time for the intermediate distance	:-	0.98 sec/hole
IV) Time required for machining (whole depth)	:-	9.00 sec/hole
Total		<u>13.763 sec/hole</u>

Due to the modification the time saved is

$$(21.128 - 13.763) = 7.365 \text{ sec/hole}$$

$$\begin{aligned} \text{Equivalent cost saving in Tk} &= \text{Tk } 0.02333/\text{hole} \times 7.365 \text{ sec/hole} \\ &= \text{Tk } 0.1718/\text{hole}. \end{aligned}$$

Cost involved in modification:-

Jig bush, holder & assembly	=	Tk 200/-
Welding cost	=	Tk 40/-
Pin, Pin holder & spring	=	Tk 60/-
Total		<u>Tk 300/-</u>

For the sack of Tk 300/- the machining time reduced by an amount 7.365 sec/hole so the cost saving per hole is 0.1718 Tk/hole.

Therefore the number of hole required to recover the cost

$$= \text{Tk}300/\text{Tk}0.1718 \text{ per hole} = 1746.2 \approx 1747 \text{ nos.}$$

The modified variant of first type will start earning profit after drilling 1747 nos. of hole. The recommended value of drilled holes in a day is 1500 nos. Considering that working days in a year are 300, the recommended value of drilled hole in a year is $1500 \times 300 = 45 \times 10^4$ nos. on a particular machine.

After the provision period of 1747 nos of hole the machine will earn an additional profit of $(45 \times 10^4 \times 0.1718) = \text{Tk } 77,310/\text{yr.}$

The demerits of the first variant

1. It may drill only single type of faller bar.
2. The intermediate distance between two successive grills should be multiple of the center distance between two successive pin.

Due to these shortcomings the variant designed is unable to serve all the purposes.

The second variant

To eliminate the shortcomings of the first variant in the second variant a set of three screws introduced so that all the three groups of faller bar may be drilled for insertion of the pins.

Cost involved in modification:-

Jig bush assembly	= Tk	300/-
Gears (8 nos.)	= Tk	1450/-
Shafts (2nos.)	= Tk	100/-
Key (3nos)	= Tk	50/-
Screw(3nos)	= Tk	750/-
Wheel(1 nos.)	= Tk	80/-
Pin, pin holder, spring	= Tk	60/-
Lever arrangement	= Tk	150/-
Collar	= Tk	100/-
Others	= Tk	50/-
Total	= Tk:	3070/-

For the value addition the additional advantage may got is that all the three groups may be drilled.

Aproximate time rates for the given variant:-

Time for clamping & unclamping	:-	0.283	sec/hole
Time for indexing center distance	:-	3.5	sec/hole
Time for indexing intermediate distances	:-	0.083	sec/hole
Time for drilling of the hole	:-	9.00	sec/hole
Time for changing screw for different set	:-	0.94	sec/hole
Total	=	13.806	sec/hole

Time required in the existing variant = 21.128 sec/hole.

Time saved due to proposed modification

$$21.128 - 13.806 = 7.322 \text{ sec/hole}$$

$$\text{Therefore equivalent cost saving} = 7.322 \text{ sec/hole} \times 0.023334 \text{ Tk/sec} \\ = 0.1708 \text{ Tk/hole}$$

$$0.171 \text{ Tk/hole}$$

So, the number of holes to be drilled to recover the investment

$$= 3070 \text{ Tk} / 0.171 \text{ Tk per hole}$$

$$= 17953.21 \text{ holes}$$

$$\approx 17954 \text{ holes}$$

$$\approx 18000 \text{ holes}$$

$$\text{Number of working days required to drill } 18,000 \text{ hole} = 18000 / 1500 \\ = 12 \text{ days.}$$

After the provision period the assembly will save

$$= 45 \times 10^4 \times 0.171 =$$

$$= 76950 \text{ Tk/yr.}$$

Demerits of this variant:-

Frequent screw changing is a cumbersome job.

The third variant

In this variant rather than changing the screws a gear set or sets are changed to reduce the idle time, because changing of screw requires more time and efforts than that of a gear set & that is why a gear set is introduced here.

In this arrangement following parts are to be added with the existing variant.

Cost involved in modification:-

Gear	14 nos	= Tk	2500/-
Key	6 nos	= Tk	60/-
Shaft	2 nos	= Tk	100/-
Wheel	1 no	= Tk	80/-
Jig arrangement		= Tk	300/-
Pin arrangement		= Tk	60/-
Collars	2 nos	= Tk	200/-
Others		= Tk	150/-
Total		Tk	3450/-

Approximate time rates for the modified variant-3.

Time required for clamping & unclamping	=	3.5 sec/hole
" " " indexing center hole	=	0.083 "
" " " lever changing	=	0.003 "
" " " indexing intermediate distance	=	0.083 "
" " " Drilling of the hole(whole depth)	=	9.00 "
" " " changing gear setting(once a day)	=	0.015 "
Total	=	12.884 "

Time saved for the cost of Tk 3450/-.

$$(21.128 - 12.884) \text{ secs/hole} = 8.244 \text{ secs/hole.}$$

∴ Tk saved for the time savings

$$8 \cdot 244 \text{ sec} \times 0 \cdot 02333 \text{ Tk/sec} = 0 \cdot 1923325 \text{ Tk/hole} \\ = 0 \cdot 192 \text{ Tk/hole.}$$

No of-hole to be drilled to recover the investment

$$= \frac{\text{Tk } 3450/-}{0 \cdot 192 \text{ Tk/hole}}$$

$$= 17968 \cdot 75 \text{ holes}$$

18000 holes

Time required to machine these holes $= (18000/1500) = 12$
 $= 12 \text{ days.}$

After 12 working days the new assembly will save $(\text{Tk } 0 \cdot 192/\text{hole} \times 45 \times 10^4 \text{ hole/yr})$
 $= 86400 \text{ Tk/yr}$ at a rate of $\text{Tk } 0 \cdot 192/\text{hole.}$

The Fourth variant

In this variant the number of parts are greatly reduced also the events of operation. To convert the revolving motion into the linear motion the mechanism used is rack & pinion. Here the need of lever and gear changings are avoided so the chance of errors are greatly reduced.

Approximate cost involved in modification:-

Wheel	1 nos	= Tk 500/-
Gear	4 nos	= Tk 700/-
Rack	1 no	= Tk 500/-
Jig arrangement		= Tk 300/-
Total		= Tk 2000/-

B.F.		= Tk 2000/-
Pin arrangement		= Tk 160/-
Shaft	3 nos	= Tk 250/-
key	2 nos	= Tk 20/-
Others		= Tk 100/-
Total		= Tk 2530/-

Approximate time rate for the variant-4.

Time required for clamping & unclamping		= 0.283 sec/hole
" " " Indexing center hole		= 1.8 "
" " " " Intermediate distance		= 0.020 "
" " " " drilling holes		= 9.00 "
" " " changing pin set		= 0.04 "
Total		= 11.143 "

Time saved = $(21.128 - 11.143)$ sec/hole = 9.985 sec/hole

Tk saved = Tk $0.02333/\text{sec} \times 9.985 \text{ sec/hole}$ = 0.23295 Tk/hole
0.233 Tk/hole.

Therefore the number of holes required to be drilled to get back the incurred expenses = $\text{Tk } 2530 \div 0.233 \text{ Tk/hole}$

= 10858.369 nos.

= 10,859 nos.

After $(10859 \text{ hole} \div 1500 \text{ holes/day}) = 7.2$ working days will save Tk

Tk 104,850/yr $(0.233 \text{ Tk/hole} \times 45 \times 10^4 \text{ holes/yr})$ at the rate of

Tk 0.233/yr/hole.

In the above calculation the cost involved due to the breakage of drill bits is not taken into consideration, so the actual rate of profit may be higher.

The important points of consideration of the modified variants are given below in the table - 5 for comparison.

TABLE - 5

Feature	Present variant	First variant	Second variant	Third variant	Fourth variant
Cost incurred during modification(Tk)	0	300	3,070	3,450	2,550
Average time saved with respect to the existing variant(sec/bole)	0	7.365	7.322	8.244	9.985
Break even point(nos of holes)	0	1,747	18,000	18,000	10,858
Increase in the yearly profit(Tk)	0	77,310	76,950	86,400	104,850

§ 4.2 TECHNICAL EVALUATION OF THE MODIFIED VARIANTS

Operation

From the operational point of view the best index jig is the Fourth variant. Its advantages over the other variants are as follows: -

1. In this variant, to set for another group of faller bars it only requires to change a few parts, which will require a very short time.
2. In this variant, there is no chance of mistake because jig ~~itself gives the signal~~ of finishing i.e. wheel does not rotate while it reaches at the final point of indexing.
3. There is no need of skilled labourer, a new man can easily operate this jig.
4. Provision for drilling new groups of faller bars.

The disadvantages are:

1. Major change in the parts.
2. Accuracy mainly depends on the accuracy of location of the wheel holes.

Considering its wide range of usefulness, this index jig may safely be named as universal jig.

From the operational point of view the second or third variant may be placed just after the fourth variant.

TABLE-5

Sl No.	Feature	Second variant	Third variant
1	Number of revolution required to index the center holes.	one	one
2	The number of rotation required to index the intermediate distance	one	one
3	Force required to rotate the wheel	low	low
4	Mechanism used to change the setting from the center hole indexing to the intermediate distance	changing of a gear set by a lever	changing of a gear set by a lever.
5	Efforts required to change the setting for different variant	It is required to change a screw which is a cumbersome job	It is required to change two pair of gears which can be easily done

From the table it is clear that the second variant must leave the second position for the third variant.

The only position remains there is the fourth position and it is for the first variant, the reasons are as follows:

1. Since the screw used is of 6(six)thread/inch & hence the distance travelled by the table is $1/6$ inch for one revolution of the wheel ~~is, further more.~~
2. For the same reason the intermediate distance between the two successive grills must be a multiple of the $1/6$ inch.

Practically there is no existence of such kind of faller bar which requires an indexing of center distance of $1/6$ inch.

4.3 MANUFACTURIBILITY OF THE VARIANT(MODIFIED)

To manufacture the first variant the parts required are

- a) Pin
- b) pin holder
- c) spring.

For the second variant the following parts are necessary:

- a) gears 4 nos.
- b) shaft 2 nos.
- c) keys & spring
- d) a few supports
- etc.

Naturally First variant is better than the second variant.

The third variant requires

- a) gears 14 nos.
- b) shaft 3 nos.
- c) pin, pin holder
- d) lever, key & spring.
- e) other supports
- etc.

So the second variant is better than the third variant. Now the position of the new variants are First variant is 1st, second variant stand second & the third position is for the Third variant.

The fourth variant requires

- a) gears 4 nos.
- b) rack 1 nos.
- c) wheel 1 nos.
- d) pin, pin holder, spring.
- e) shaft 3 nos.
- f) keys
- etc.

Fourth variant requires a rack but the third variant requires 14 nos of gears, previously it was shown that the manufacturing cost of the fourth variant is less than that of the third variant. So from the manufacturing point of view , the fourth variant can be placed third leaving the fourth place for the third variant.

For a comparative study the values of different parameters of the four variants are given in the table-7. And from the table-7 the variants can be placed according to the order of their merits as follows:

1. Fourth variant
2. Third variant
3. Second variant
4. First variant.

CONCLUSION

The purpose of the present work was to do some useful work for our industrial sector. After proper analysis of concrete problem of drilling faller bars, as performed in Bangladesh Machine Tools Factory, Gazipur, it was decided that an index jig can save a tremendous amount of efforts, machining time, operators fatigue and ultimately lower down to a great extent the cost of production.

An analysis of the various types of faller bars, that are machined in BMTF, it has been found that number of jigs necessary to drill them are much lower than their group member. Four different variants of index jigs have been designed for comparative analysis. Amongst them three variants are capable of machining all the three groups of faller bars (into which the six faller bars have been grouped) with little or no change in the arrangements of the variants. This has been clearly shown in chapter-3.

In the present work some recommendations has been made to change the existing technology of drilling holes. He proposes to combine two separate operations, namely marking & drilling into single operation. This should be possible due to the fact that, there is

provision in all the new variants for completely fixing the machine table during the actual drilling operation.

A drill bush has been introduced in the proposed variants. The bush designed is replaceable type, so that it can be easily replaced after it has been worn out. This bush is supposed to raise the drill life by a considerable amount due to better guiding of the tool and improved chip removal facilities, which have been discussed in chapter III of the present work.

Results of the comparative economic analysis of the four designed variants with reference to the existing factory variants has shown that, it is possible to reduce the cost of production in this operation by approximately Tk. One lakh per year if an index jig be used.

The jig designed will save not only money but also will definitely save the eye sight of the operators, since now operators would not have to locate each marked point for drilling, indexing will done rather mechanically in the proposed variant.

Technological, economical and other comparisons have proved the rationality of proposing the Fourth variant for factory use. It may be mentioned that with the Fourth variant indexing is done using an

indexing wheel. Analysis have shown that, this variant can be very easily operated by the operators.

The author of the present work has tried to make a qualitative analysis of the different variant by economic calculations. The quantitative aspects of the analysis may suffer from certain shortcomings, which again are due to limited scope of the project work.

PROVISION FOR FUTURE IMPROVEMENT.

The Jig-Fixture assembly may easily be adapted to a new variant of faller bars. For the new variant of faller bar either little or no change has to be made in the existing variant.

The proposed variant may easily be automated. This can be done if an electric motor be introduced here to give the revolving motion to the wheel for indexing and if this motion be in correlation with the downward motion of the drill spindle through levers and cam arrangements.

Since the scale of production is not too large, and the author did not aim at reducing job facilities of the humans he did not think of automating the whole operation.

New group of faller bars can easily be machined by the designed variants of jigs. For different center distance between two successive pins & distance between two grill only 2 pairs of gear is required one pair

for indexing the center distance between two pins & another pair for indexing the distance between two successive grills, in the case of 3rd variant.

In the 4th variant it is still easier to accommodate a new set of feller bars. In this variant the indexing is related to the indexing holes on the wheel it will be possible to drill a new group of feller bars.

REFERENCES

1. Fielder Report: Department of Engineering Production,
University of Birmingham
2. Matousek R. Engineering Design: A systematic approach, Blackie,
London(1963).
3. An unpublished collection, Azim M. Anwarul, BUET, Dhaka.
4. Donaldson Cyrill, Lecain George H.: Tool Design. 2nd edn
1957, McGraw Hill Book Co. Inc.

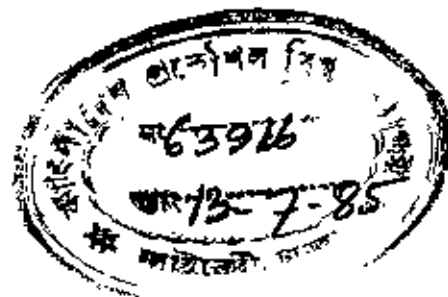

This dimension must be before

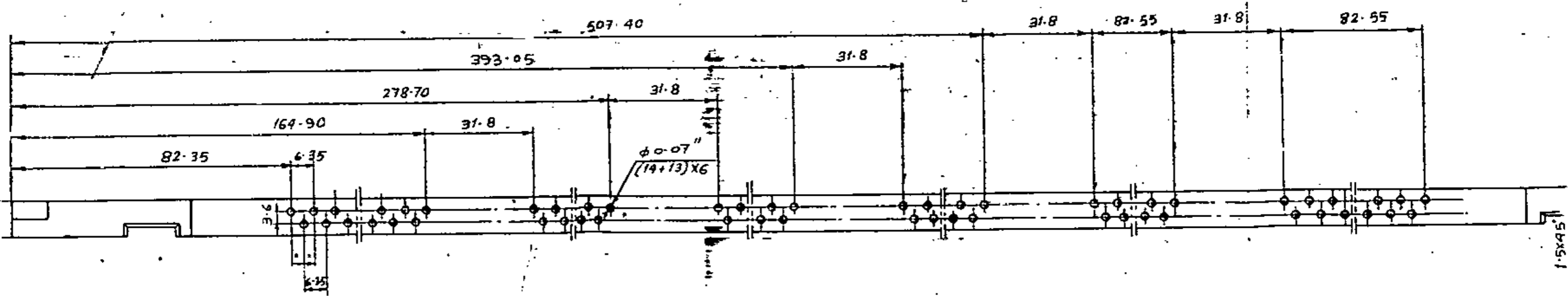
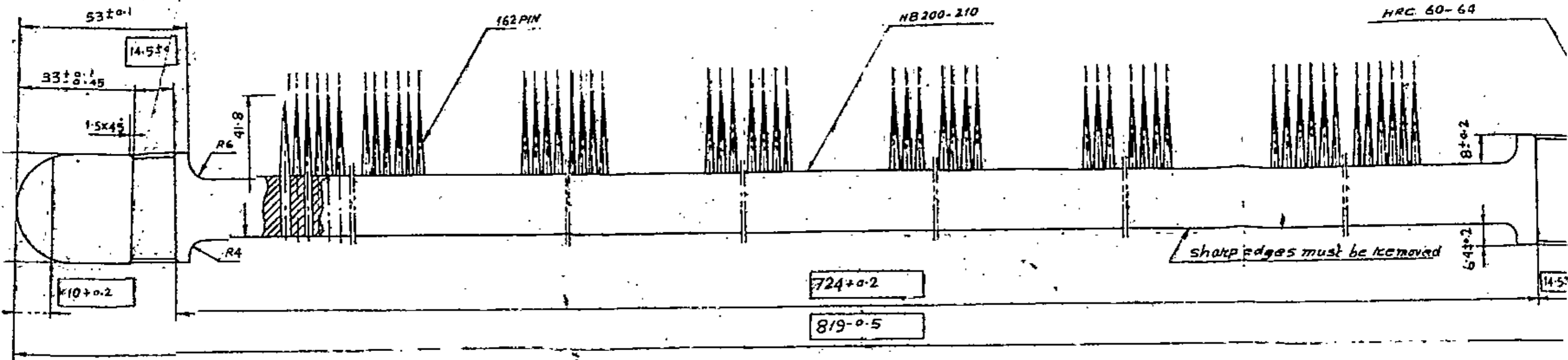

TECHNICAL REQUIREMENT

1. Bend of the middle portion & twist of the head to be checked after heat treatment
2. The pins should be light press fitted so that they can be removed
3. All sharp edges are to be removed
4. Control dimensions are given in the drawing

SIZE	No of grill	No of row	No of pin / grill

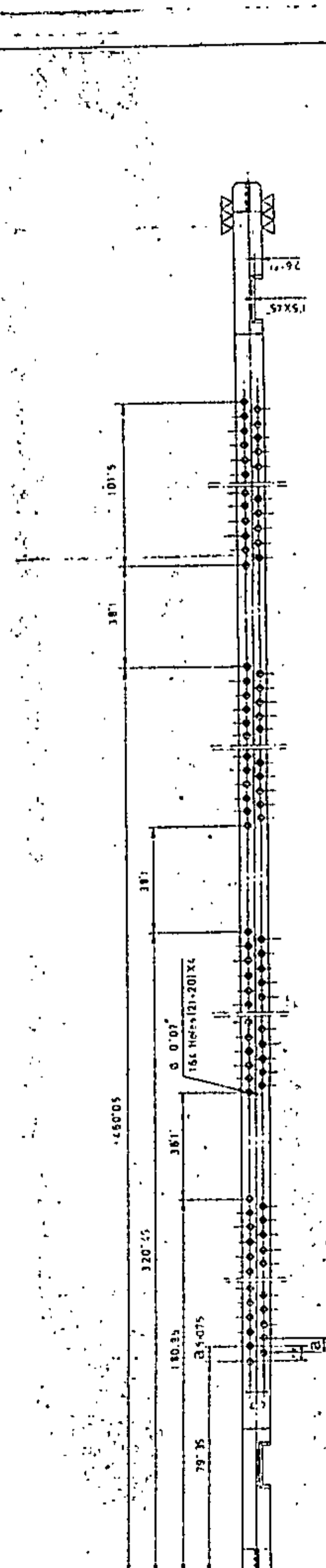
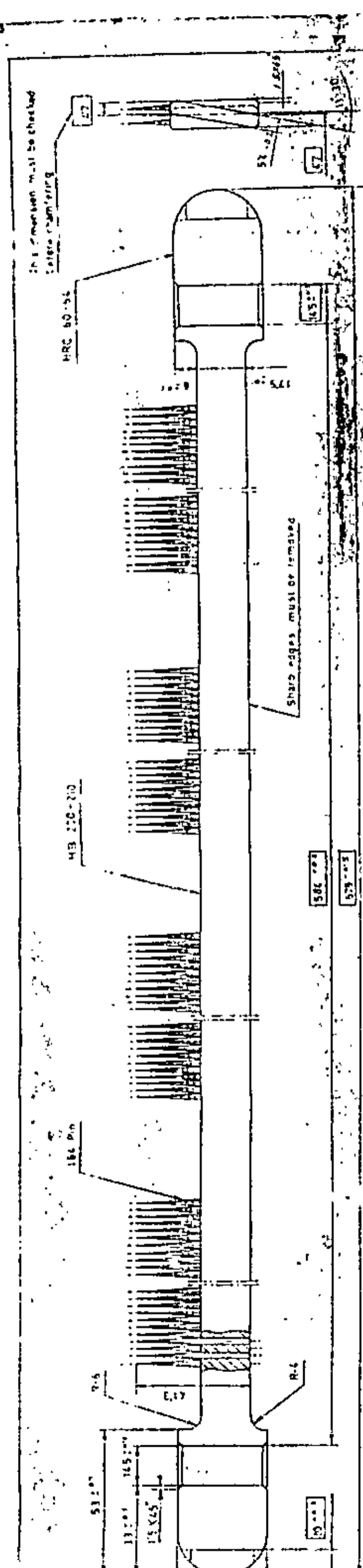

TECHNICAL REQUIREMENTS:

1. Bend of the middle portion & twist of the head to be checked after heat treatment
2. The pins should be tight press fitted, so that it can be replaced
3. All sharp edges are to be removed
4. Critical dimensions are shown in
5. Grinding pins must not be imposed after finish

SIZE	No of grill	No of row	No of pin /grill
26 3/4	4	2	21 + 20
11 1/2 - 13 1/2			
16 - 32			



ALFEE M JULE MILLS

FIG NO - 4

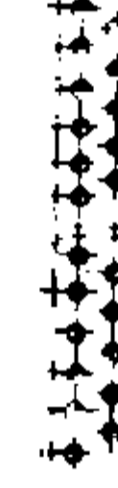
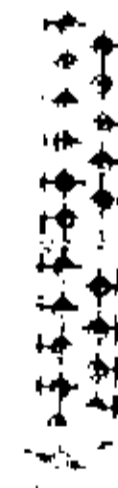
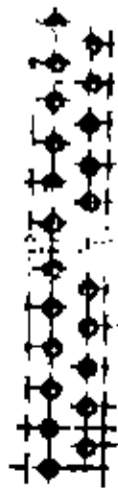
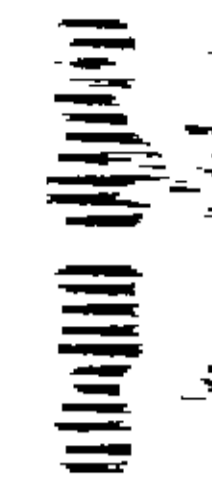
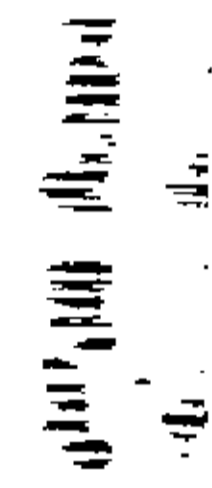

TECHNICAL REQUIREMENT

Material: ...
 Other requirements: ...

SIZE	NO OF GRIDS	NO OF ROWS	NO OF COLUMNS
26.25	13	3	21-20
16	32	4	

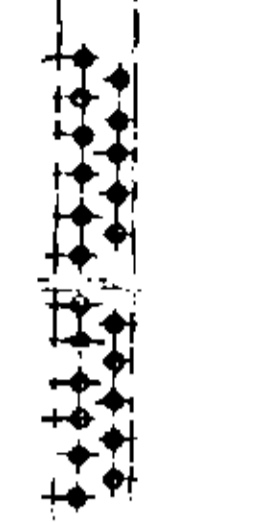
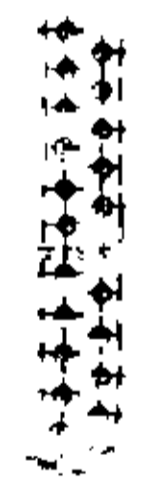
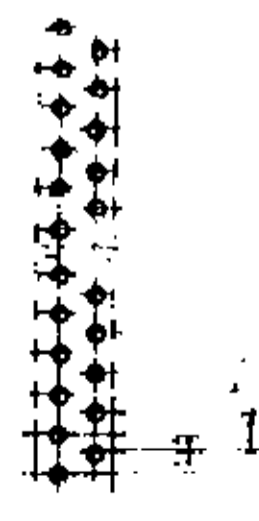
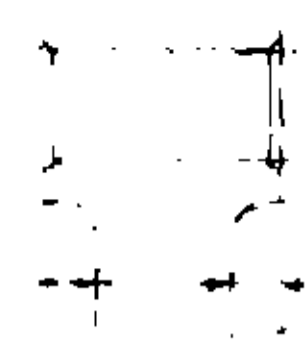
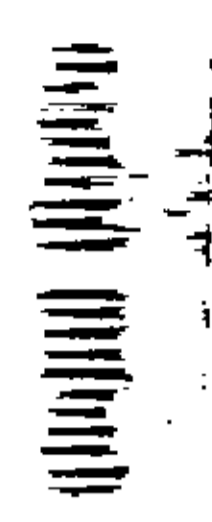

TECHNICAL REQUIREMENT

Technical drawing showing reinforcement details.

5.7E No of grids No of rows No of #n/grids

263x 11x 13 4 2 20

checked before assembly

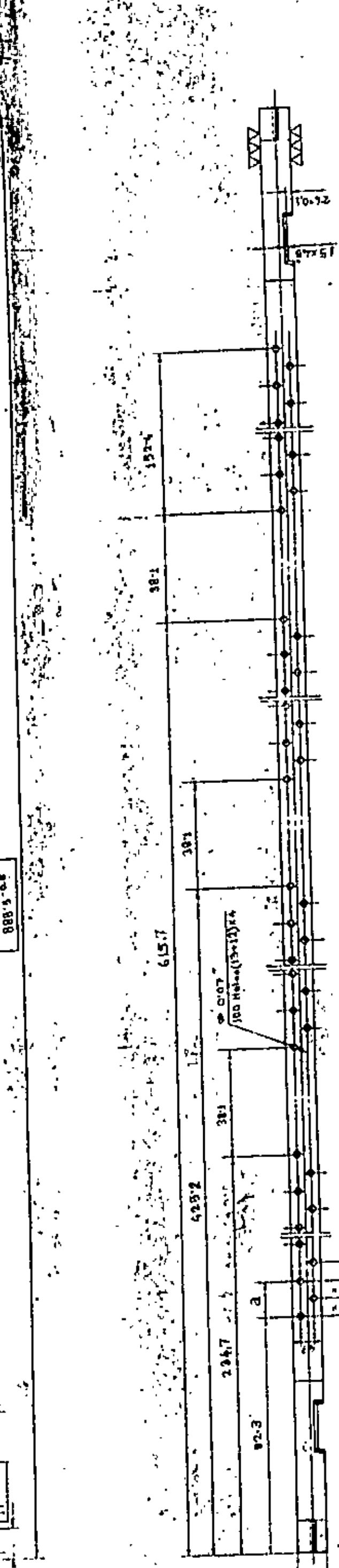
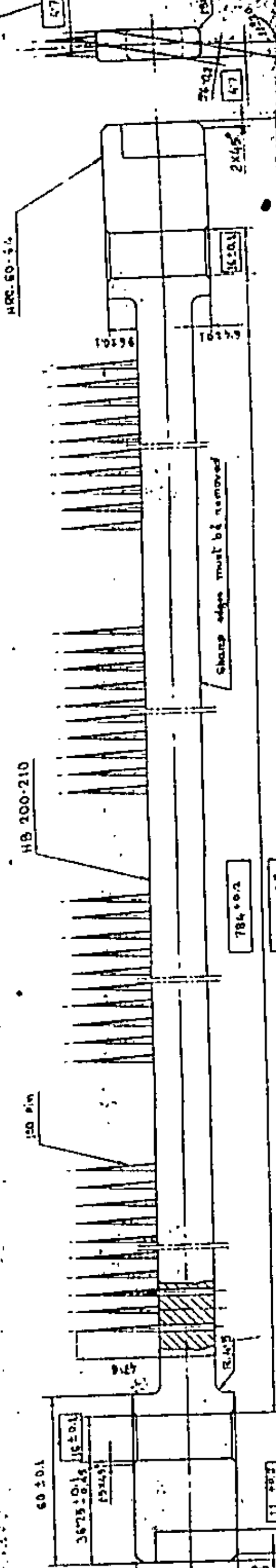

TECHNICAL REQUIREMENT:

- 1 Band of the middle portion & twist of the head to be checked after heat treatment.
- 2 The pins should be tight press fitted, so that it can be replaced.
- 3 All sharp edges are to be removed.
- 4 Centro. dimension are shown in []
- 5 Welding joint must not be exposed after finish.

Size	No of grill	No of row	No of pin/grill	a
35 X 3/4 X 3/2	4	2	12 + 13	12.7
			18 + 19	8.466

CEMENT JUTE MILL

∇∇ (∇∇∇)

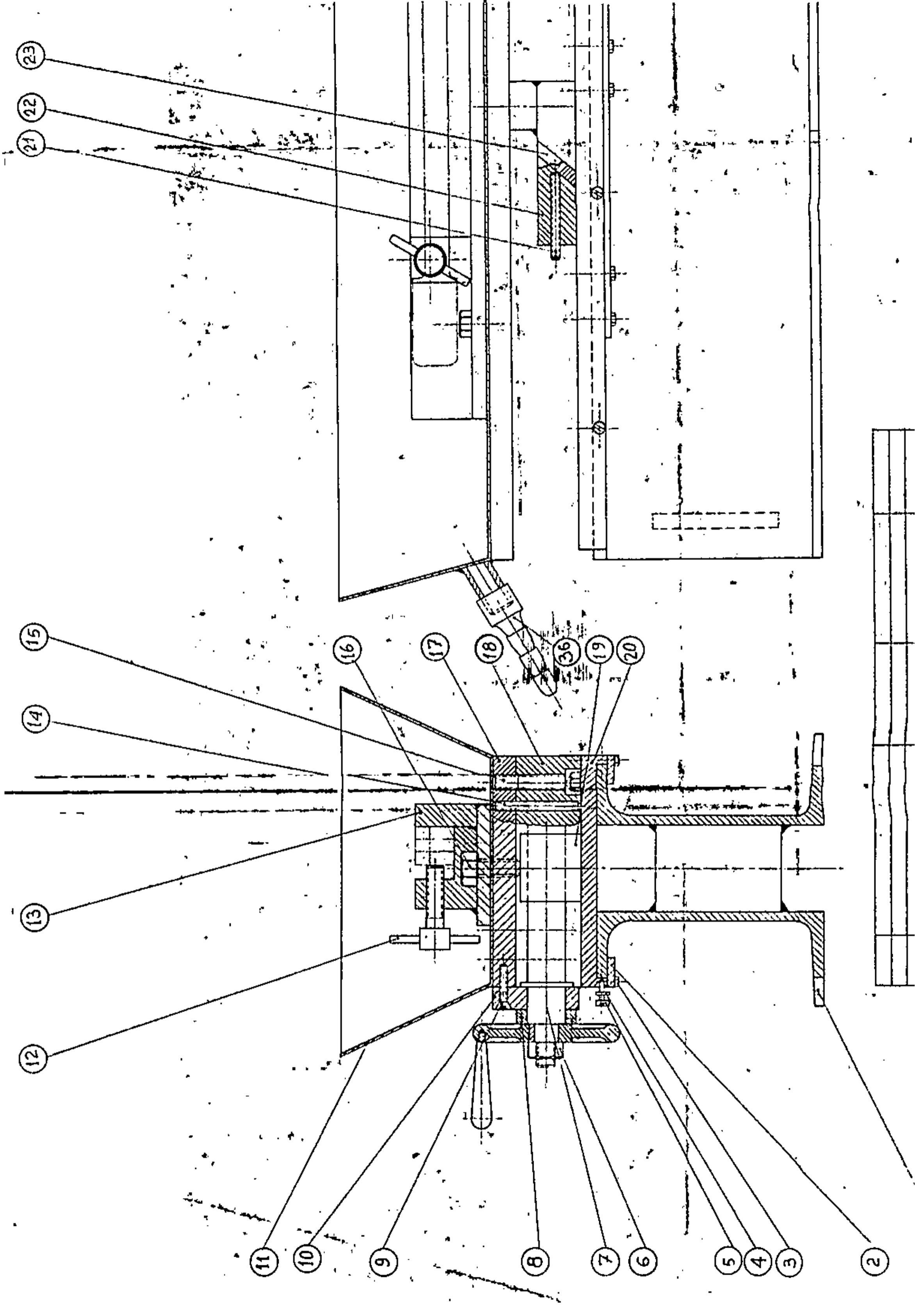

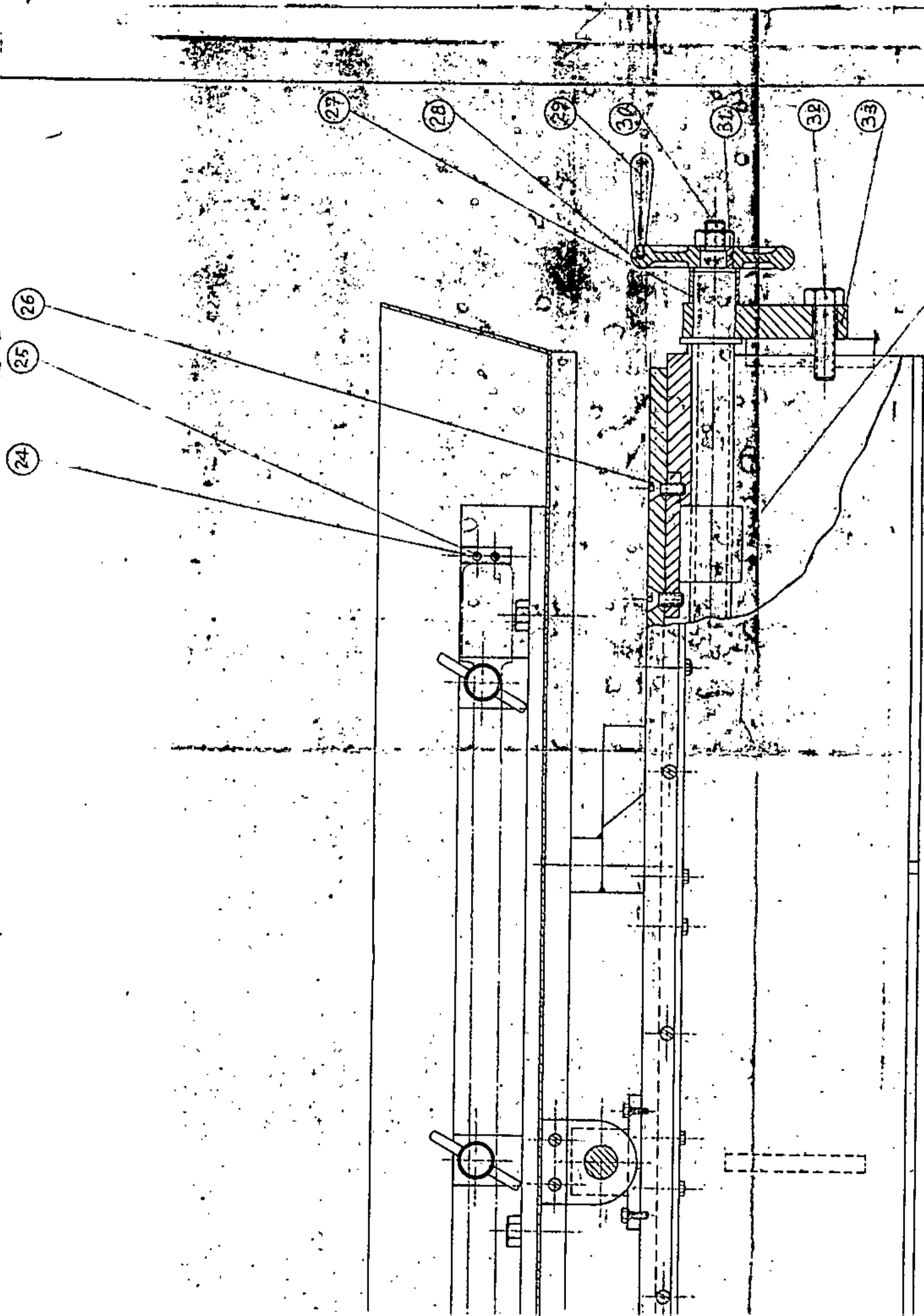

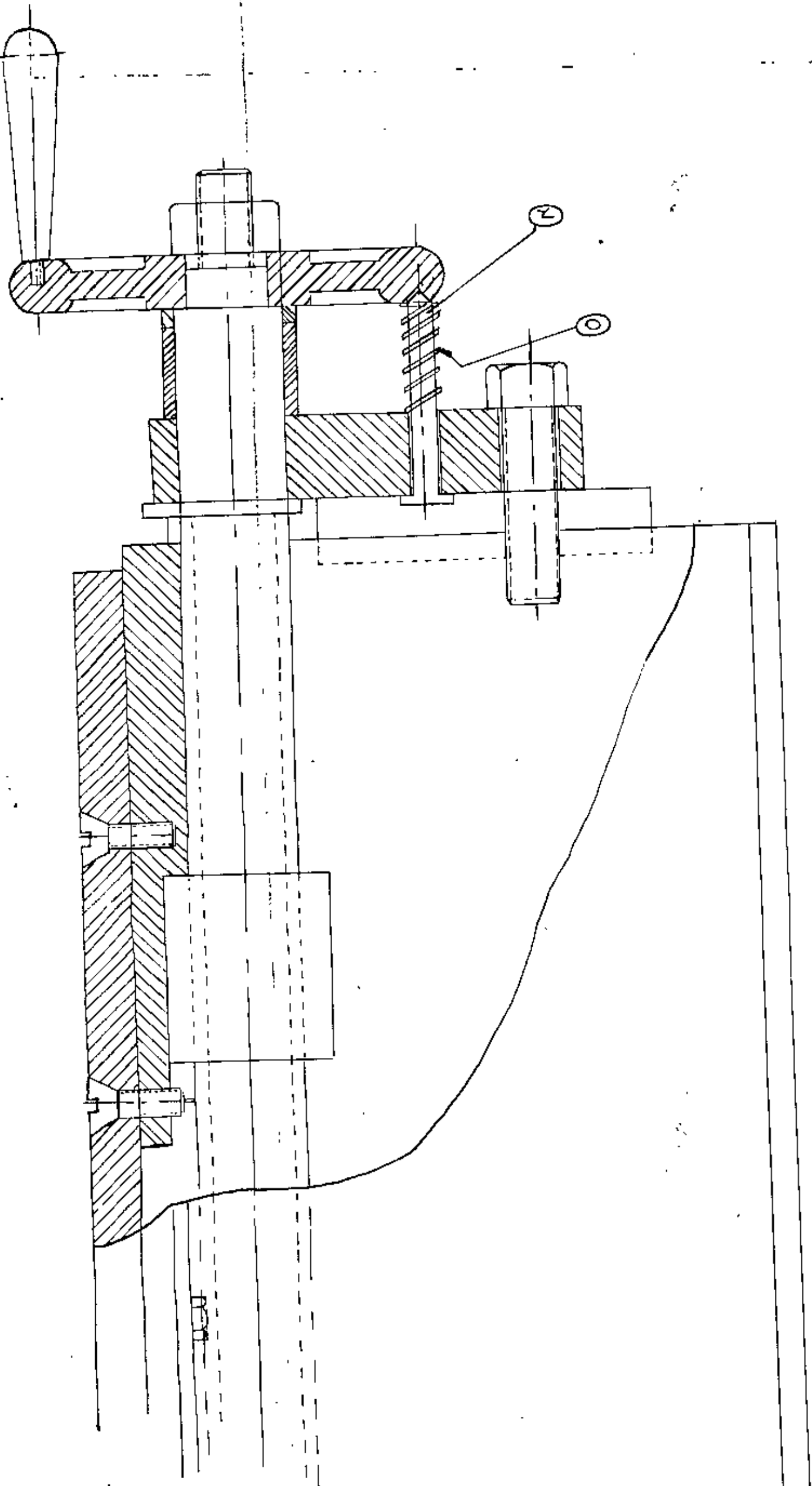

O	SPRING	1
N	PIN	BMS-2 1
INDEX	PART NAME	MAT QTY

BUET

DEPT OF I.P. ENGINEERING

TITLE - ASSEMBLY FIRST VARIANT

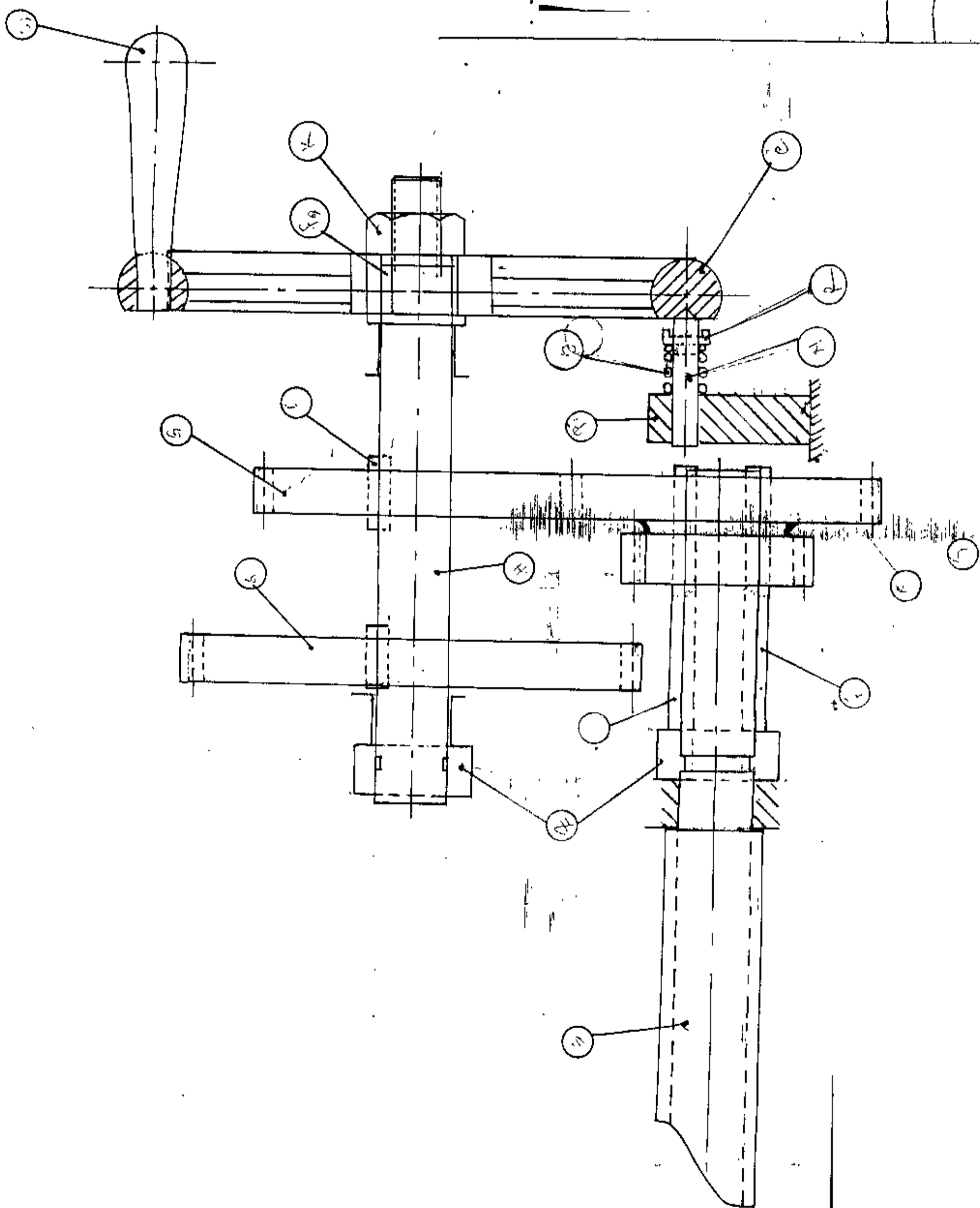

B.U.E.T

DEPT. OF I.P.E.

TITLE: ASSEMBLY (2ND VARIANT)

SCALE: FULL SIZE

APPROVED BY